

PROFILE

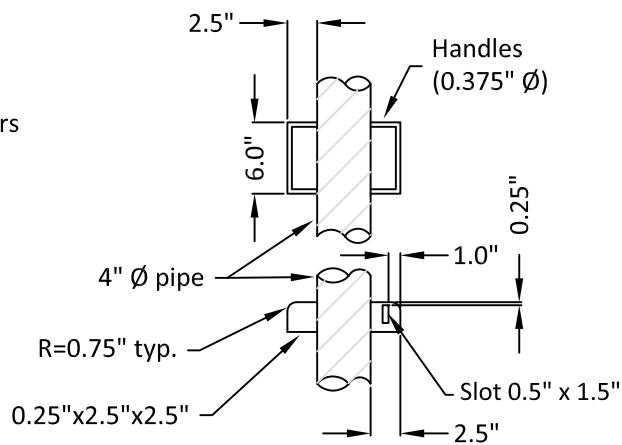

POST

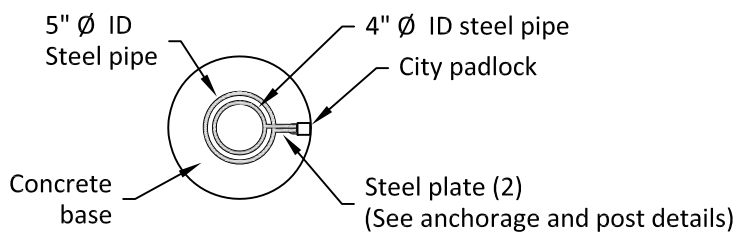

PLAN

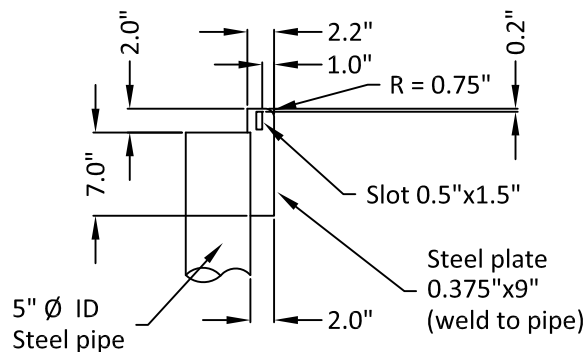

ANCHORAGE

Rev	By	Date
0	JT	08/14/06

Scale: NTS

Removable Steel Bollard

City of Palo Alto Standard

Approved by:	
PE No.	72158
Date	01/10/18
Dwg No.	703